

Boy's Hutch Page # 1

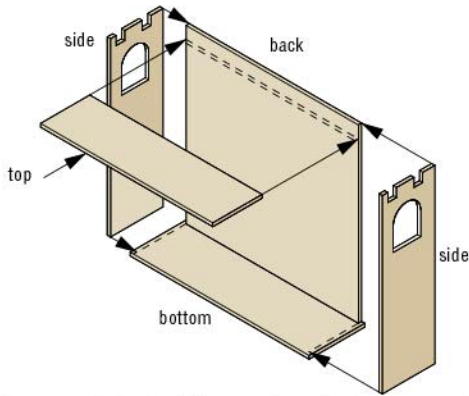

1. Assemble bottom, back, top, and sides.

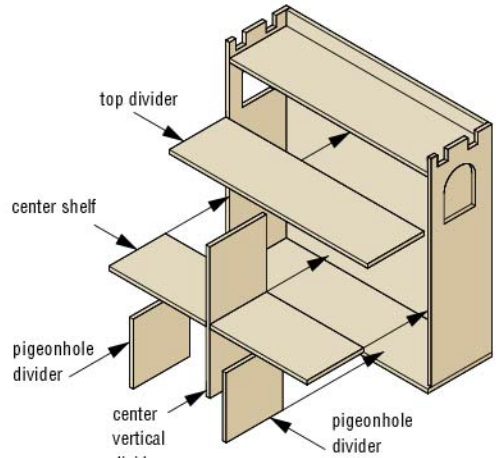

2. Assemble shelving.

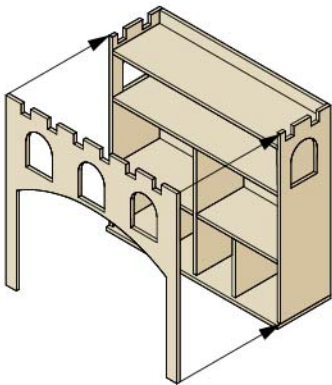

3. Install front panel.

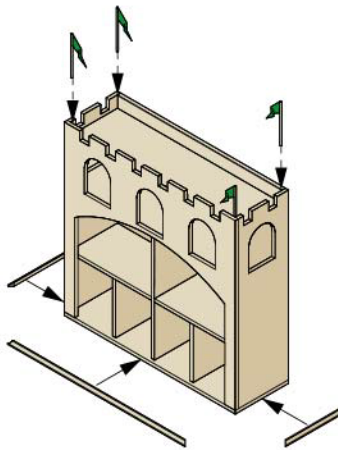

4. Add cove moulding and flags.

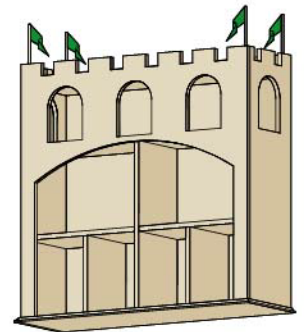

5. Paint completed castle.

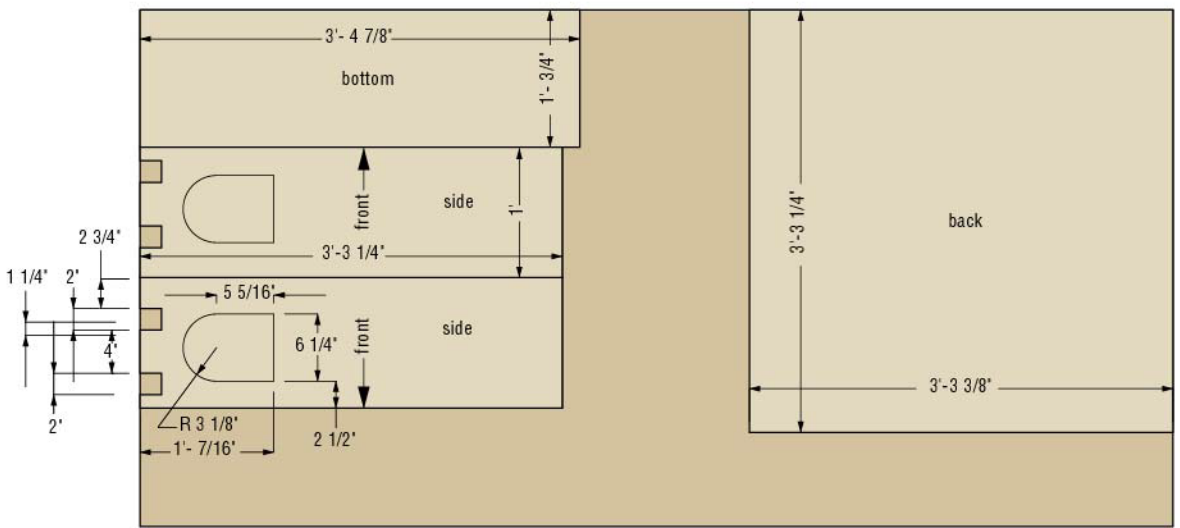

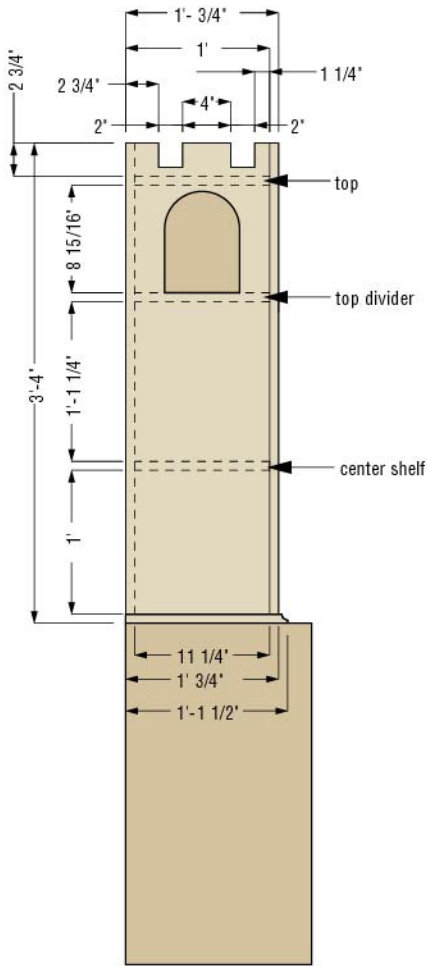

Side View

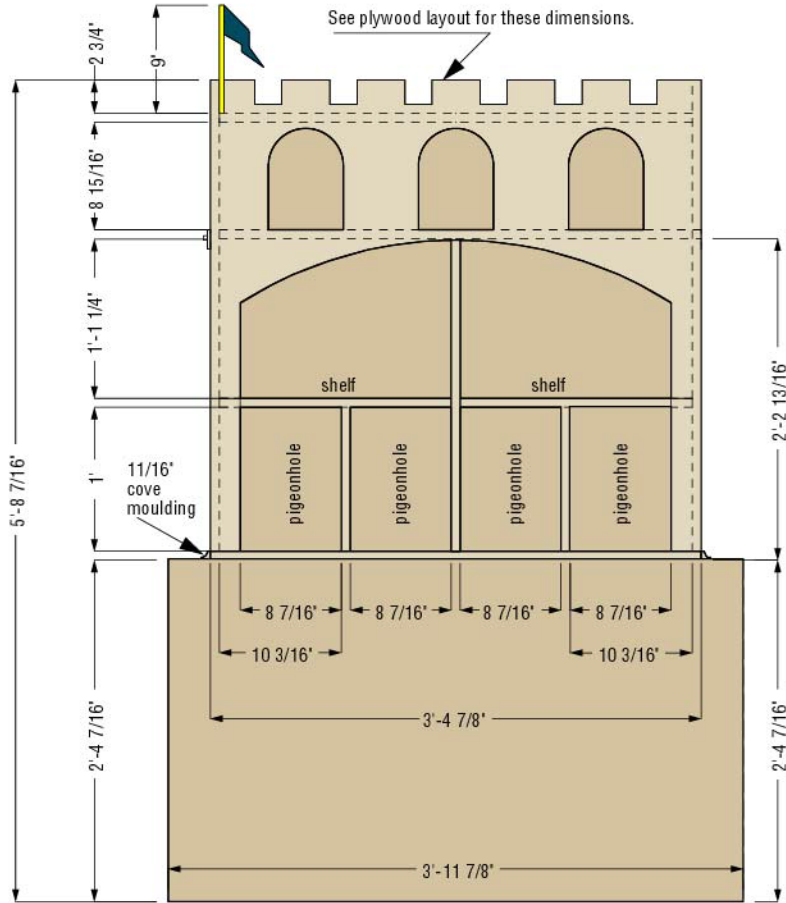

Front View

